

# South African Maritime Safety Authority

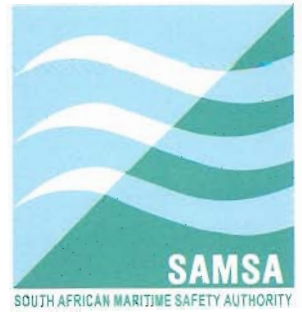

**Ref** : SM 6/5/1/1  
**Date** : 20 April 1998

## MARINE NOTICE NO. 13 OF 1998

TO ALL PRINCIPAL OFFICERS, SHIPOWNERS, SHIP'S AGENTS AND MASTERS OF VESSELS.

### IMO RESOLUTION A.866(20).

GUIDANCE TO SHIP'S CREWS AND TERMINAL PERSONNEL FOR BULK CARRIER INSPECTIONS.

The accompanying copy of documentation received from the International Maritime Organisation (IMO) is provided for your information and guidance where necessary.

**BR WATT**  
**CHIEF EXECUTIVE OFFICER: SAMSA**

C:\SERV\RW\PA\IN\Q\IN\MARINUT.WPD

**Note:** The functions of the former Chief Directorate Shipping of the Department of Transport have, with effect from 1 April 1998, been assumed by the South African Maritime Safety Authority. Kindly address correspondence to the Chief Executive Officer

### Safe Ships - Clean Seas

P O Box 13186, HATFIELD, 0028, C/o Hilda & Schoeman Street, Hatfield, Pretoria  
Tel: +27 12 342 3049 Fax: +27 12 342 3160



ASSEMBLY  
20th session  
Agenda item 9

**RESOLUTION A.866(20)**  
**adopted on 27 November 1997**

**GUIDANCE TO SHIPS' CREWS AND TERMINAL PERSONNEL FOR BULK  
CARRIER INSPECTIONS**

THE ASSEMBLY,

RECALLING Article 15(j) of the Convention on the International Maritime Organization concerning the functions of the Assembly in relation to regulations and guidelines concerning maritime safety,

RECALLING FURTHER that resolution A.797(19) urges shipowners, ship operators, shipmasters and terminal operators to take immediate measures as specified in the Annex thereto including measures for shipowners to implement a planned maintenance scheme and to conduct "owners' surveys" of cargo holds before loading and after unloading and maintain on board a log of these surveys, and that terminal personnel are aware of areas of specific concern relating to loading and unloading,

RECALLING ALSO that resolution A.744(18) requires the shipowner to maintain on board documentation relating to inspection carried out by ship's personnel with respect to structural deterioration and the condition of the coating, if any,

BEING CONCERNED at structural damages inflicted on ships carrying solid bulk cargoes which are one of the causes of the considerable number of bulk carrier losses, sometimes without trace, and the heavy loss of life incurred,

HAVING CONSIDERED the recommendation made by the Maritime Safety Committee at its sixty-sixth session,

1. ADOPTS the Guidance to Ships' Crew and Terminal Personnel for Bulk Carrier Inspections, set out in the Annex to the present resolution;
2. INVITES Governments to bring the Guidance to the attention of shipowners, ship operators and shipmasters of ships entitled to fly their flag as well as to terminal personnel concerned, and to urge them to implement it as appropriate;
3. REQUESTS the Maritime Safety Committee to keep the Guidance under review and amend or extend it, as necessary.

I:\ASSEMBLY\20\RES\866.

For reasons of economy, this document is printed in a limited number. Delegates are kindly asked to bring their copies to meetings and not to request additional copies.

## ANNEX

**GUIDANCE TO SHIPS' CREWS AND TERMINAL PERSONNEL  
FOR BULK CARRIER INSPECTIONS****1 PURPOSE**

1.1 This document is intended to provide guidance to ship's crew and terminal personnel with respect to the principal areas on bulk carriers that are likely to be susceptible to corrosion or damage.

1.2 Under the Guidance, it is considered the responsibility of the owner to maintain and, where necessary, report on deficient conditions found, together with any repair(s) carried out. This document is intended to provide guidance to personnel not experienced in conducting inspections. To facilitate effective discharge of this responsibility and recognizing the normal duties of ships' crew and terminal operators, it has been thought desirable to provide them with a simple guide that explains the areas of principal concern.

1.3 In this connection, it should be understood that the ship's crew and terminal operators may not be qualified in the inspection of ships. It should also be recognized that such inspections cannot in any way replace surveys conducted by flag States or recognized organizations acting on their behalf.

1.4 This document is also considered as an appropriate basis for assisting in the implementation of an effective programme to maintain the ship in a satisfactory condition between the required periodical surveys.

**2 INTRODUCTION**

2.1 Responsibility for performing periodical inspection of the hull structure of bulk carriers in accordance with the Enhanced Survey Programme (ESP) rests with the flag Administration or recognized organization.

2.2 It is important to recognize, however, that severe structural damage may occur to bulk carriers due to loading/unloading operations. Such damage may occur instantly, and may, in severe cases, endanger the ship's safety unless rectified rapidly. Furthermore, minor cracks, which have been undetectable at a given ESP survey, may develop into serious defects prior to the next ESP survey.

2.3 In view of this, it is recommended that terminal operators and members of the ship's crew themselves regularly inspect the cargo holds, hatch covers and ballast tanks with a view to detecting damage and defects. ESP documentation should be used as guidance on specific parts of the structure needing particular attention in individual ships.

2.4 From a safety point of view it is desirable that inspections of cargo holds by the ship's crew or terminal operators are conducted before all loading and after all unloading operations, although practical limitations will have to be taken into account.

2.5 To maximize the effect of such inspections by ship's crew or terminal personnel, an appropriate log of such inspections should be kept on board. For inspections performed by the ship's crew, it is recommended that the form "Owner's Inspection Report" incorporated in resolution A.744(18) on ESP be used for this purpose, and made available for surveyors from the flag Administration or recognized organization. This report will also assist the shipowner in developing the survey programme, in co-operation with the flag Administration or recognized organization, which is required by SOLAS.

### 3 GENERAL

3.1 A bulk carrier is a cargo ship designed and built for carriage of dry bulk cargoes such as grain, coal, ore, etc. The cargo hold structure with topside tanks at both shoulders and double bottoms with hoppers at both wings has been designed as the best structure for dry bulk cargo transportation. The shape of topside tanks provides sufficient stability to prevent dangerous cargo shift, and bilge hoppers contribute to convenience in collecting the cargoes on discharge.

3.2 In addition to light bulk cargoes, coal and ore are the main cargoes carried. Coal and light bulk cargoes are stowed in every cargo hold. Iron ore, however, is usually shipped in alternate cargo holds because of its high specific gravity. This is done for the purpose of avoiding excessively stiff ship motion and also for the convenience of loading facilities.

3.3 On designing a bulk carrier, loading patterns and sequences reflecting the specific gravities of intended cargoes and ballasting patterns in various operation modes are taken into consideration. These design considerations are described in loading and operation manuals which provide ship officers with basic loading patterns, strength features and limitations of the ship.

### 4 DEFINITIONS AND TERMINOLOGY

4.1 **Bulk carrier:** a bulk carrier is a cargo ship intended for carriage of dry bulk cargoes such as grain, coal, ore, etc., provided with topside tanks at both shoulders and bilge hoppers in both double bottom wings in the cargo space. Below is a typical midship section and general arrangement.

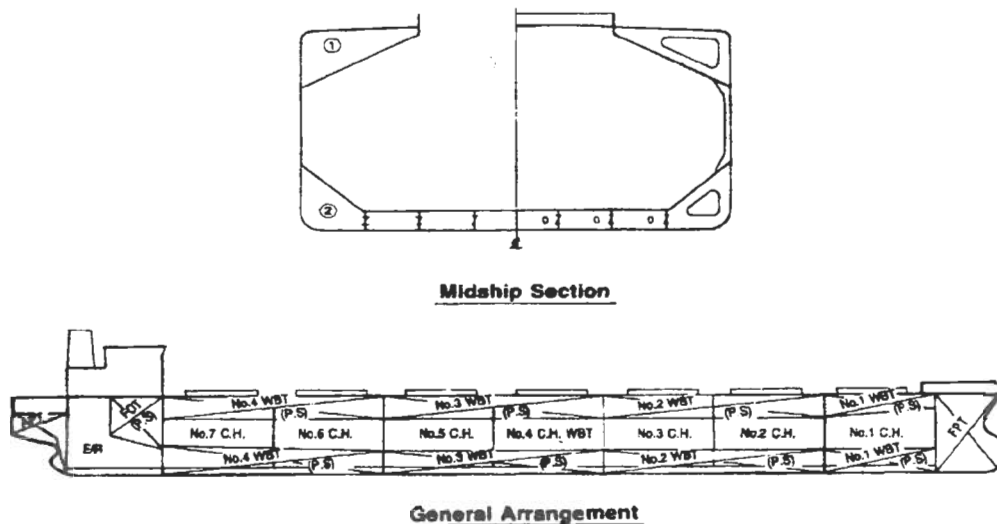

Figure 1: Typical midship section and general arrangement

4.2 **Topside tank:** tanks provided in cargo spaces at both shoulders as the space (1) shown in the drawing above.

4.3 **Bilge hopper:** a conventional bulk carrier has hopper structures at both bottom wings in cargo holds. This part of the cargo hold is called the "bilge hopper". Double bottom tanks in way of bilge hopper are often called "bilge hopper tank". In the diagram, the space is shown as (2).

4.4 **Girder and floor in double bottom:** provided in double bottom tanks, "girder" usually indicates a strong frame usually with the full depth provided in ship's longitudinal direction. The girder fitted on the center line is called "center girder", while the others are called "side girders". "Floor" means strong framing in ship's transverse direction provided in double bottom. In double bottom beneath cargo holds, floor plates are usually solid ones with full depth of the tank. In this regard, solid ones are called "solid floors" as distinct from the others.

4.5 **Transverse web in topside tanks:** strong framing provided in topside tanks in the transverse direction, also called "transverse ring". Of a transverse ring in a topside tank, the part supporting the upper deck is called deck transverse, the part attached to the side shell is called side transverse and the part attached to the bottom is called (topside) bottom transverse.

4.6 **Transverse web in bilge hopper tanks:** strong framing provided in the transverse direction in a bilge hopper tank. Transverse webs are called "bilge hopper transverse", "side transverse" and "bottom transverse" in accordance with the name of the hull members to which they are attached.

4.7 **Framing of various kinds:** on a typical bulk carrier, framing is designed as a longitudinal system in topside and double bottom tanks and as a transverse system at cargo hold side shell. Framing fitted in ship's longitudinal direction are called "longitudinals". To identify them in detail, the name of the plate they are attached to is added, such as "deck longitudinals", "side longitudinals", "bottom longitudinals", etc. Framing attached to the side shell in the cargo holds are called "hold frames", "side frames", "main frames", "shell frames", etc.

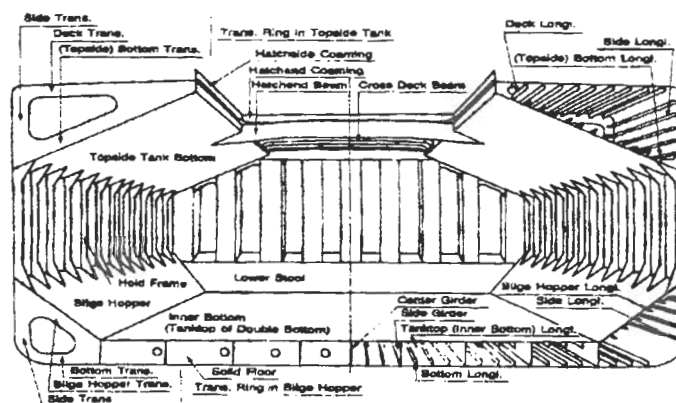

Figure 2: Typical cross section of cargo ship (bulk carrier)

## 5 GROUPING OF BULK CARRIERS ACCORDING TO DIMENSIONS

5.1 In general, bulk carriers are grouped into 3 categories according to size. These are: capesize, panamax, and other smaller types. Among the smaller types, ships of 30,000 to 45,000 dwt having 5 cargo holds are called handy bulkers. Panamax bulkers are bulk carriers having a breadth of 32.2 m, and are the largest ships able to transit the Panama Canal. Ships of this kind usually have 7 cargo holds and a deadweight of around 50,000 to 60,000 tonnes. Bulk carriers with dimensions greater than the panamax ships are called capesize bulkers. Capesize bulkers have 9 or more cargo holds and a deadweight in excess of 100,000 tonnes.

5.2 Capesize and panamax bulk carriers are generally engaged in carriage of raw materials for industrial plants, such as coal and iron ore. Smaller bulk carriers and some panamax ones are generally engaged in the trade of grain. Lumber and industrial products are generally shipped by handy size or smaller bulkers.

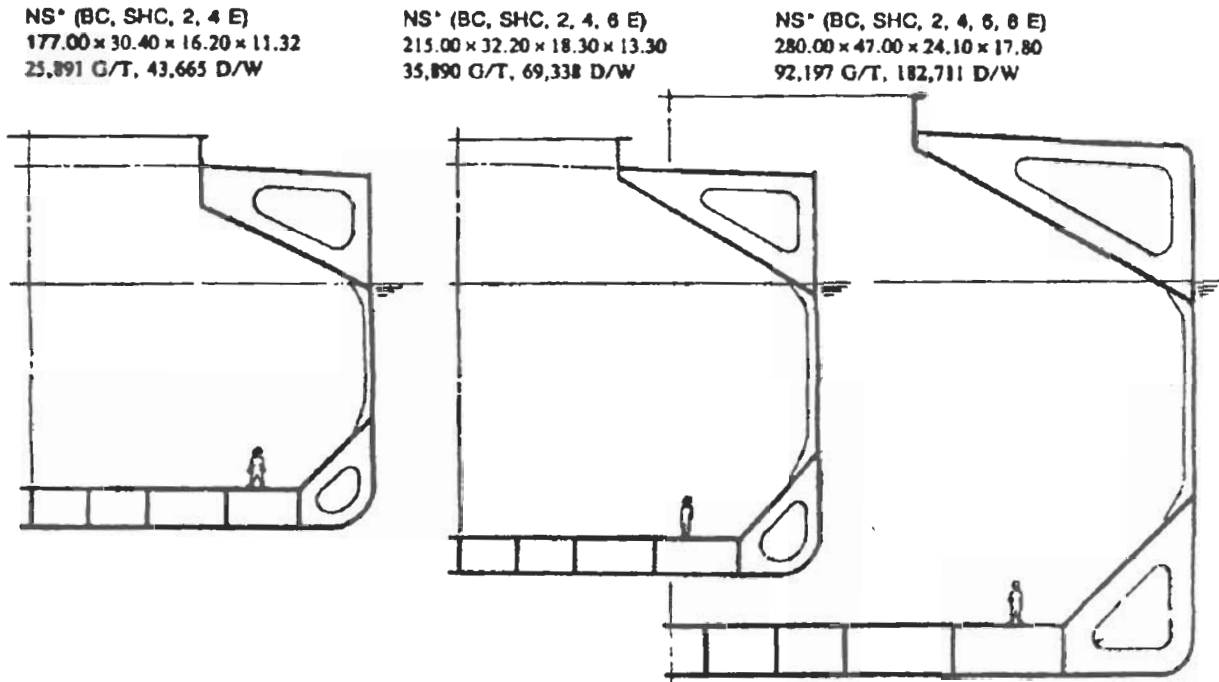

Figure 3: Various bulk carriers

5.3 In the trade of food resources such as wheat, corn, and lumber, unloading ports usually have no cargo handling facilities and the bulk carriers employed are often equipped with their own cargo gear, while panamax or capesize bulk carriers are gearless.

## 6 STRUCTURAL FEATURES AND TYPICAL DAMAGE

### 6.1 Upper deck areas

6.1.1 The longitudinally continuous upper deck of a bulk carrier suffers hull girder stress. The longitudinal bending causes an axial force on the upper deck that may cause cracking of the deck plate at the locations where the stress is concentrated.

6.1.2 Bulk carriers have cargo hatchways for the convenience of cargo handling facilities. These hatchways reduce the ship's torsional strength and invite concentrated stress at the hatchway corners which may be evident by cracking of the deck plates in these areas.

6.1.3 Cross deck strips come under stress by transverse bending. The transverse bulkheads provide transverse strength to a bulk carrier and the cross deck strips provide the strength to withstand the resultant axial forces in a transverse direction.

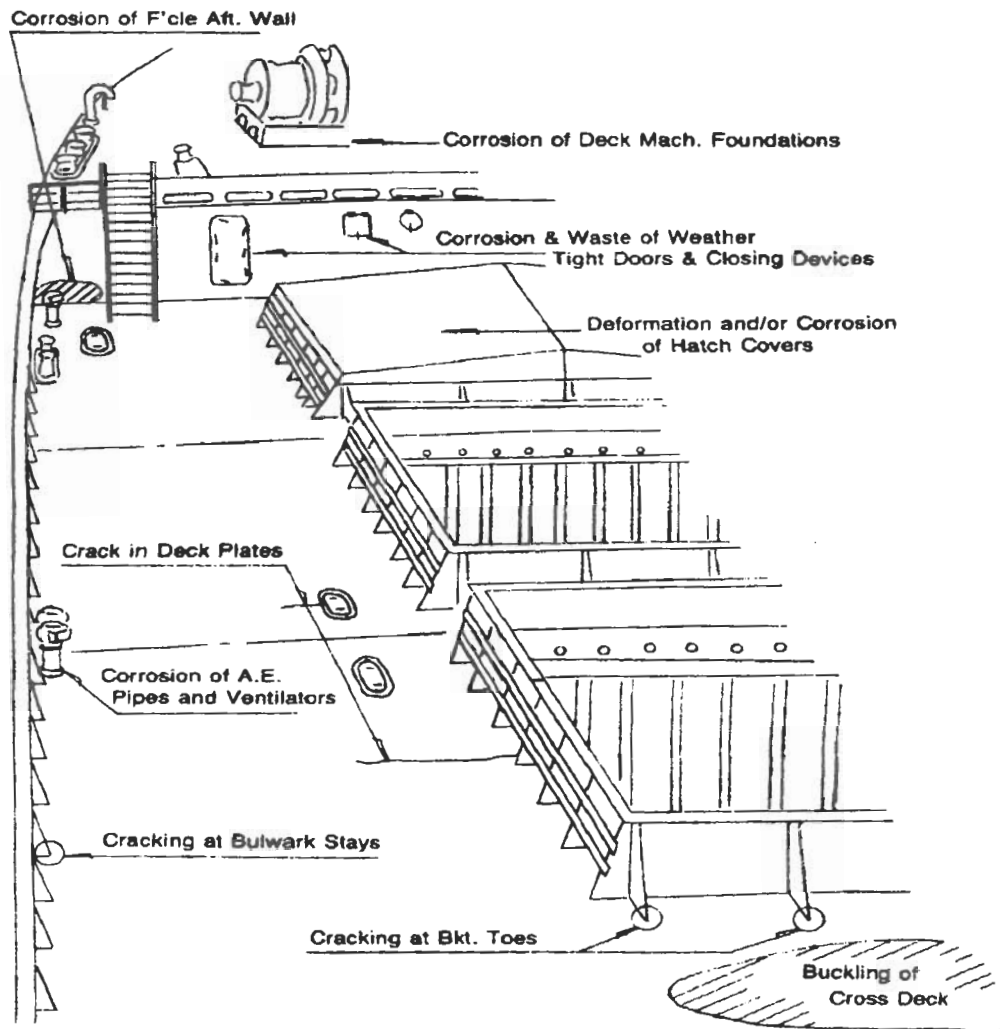

**Figure 4: Check points on the upper deck**

### Deformation

#### *Buckling of cross deck strips*

6.1.4 Generally, **longitudinal** beams are arranged under the longitudinally continuous upper deck outboard of the side lines of the cargo hatchways. This is called the longitudinal system. When the deck beams for cross deck strips are also arranged in this manner, buckling of the cross deck strips may take place due to insufficient strength against the axial forces acting on them in a transverse direction. The transverse system is the preferred method of construction for cross deck members. Particular attention should be given to buckling of the main deck on those ships where the cross deck strips are arranged in the longitudinal system.

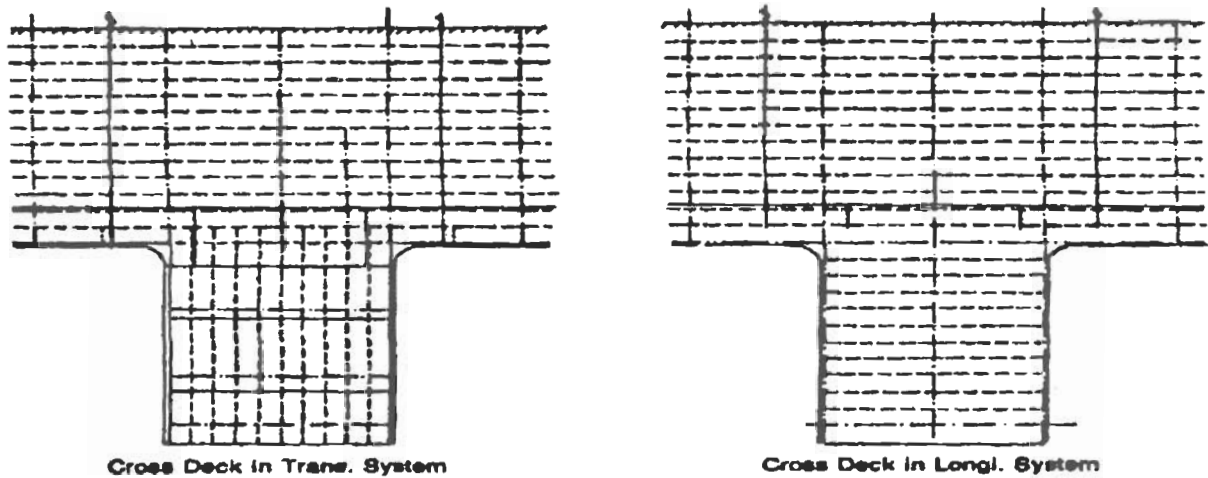

Figure 5: Comparison of stiffening systems for cross deck

**Cracking**

6.1.5 There are various types of cracking in the upper deck. Those propagating from the cargo hatchways are generally considered serious to the ship's safety:

.1 *Hatchway corners*

The large cargo hatchway openings reduce the torsional strength of the hull and invite stress concentration at their corners on the upper deck. In this regard, upper deck plating at hatchway corners is one of the focal points for cracking. Particular attention should be paid to these areas during inspection.

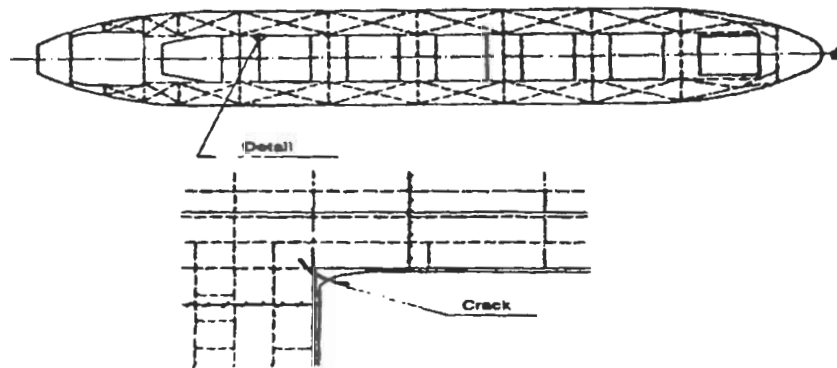
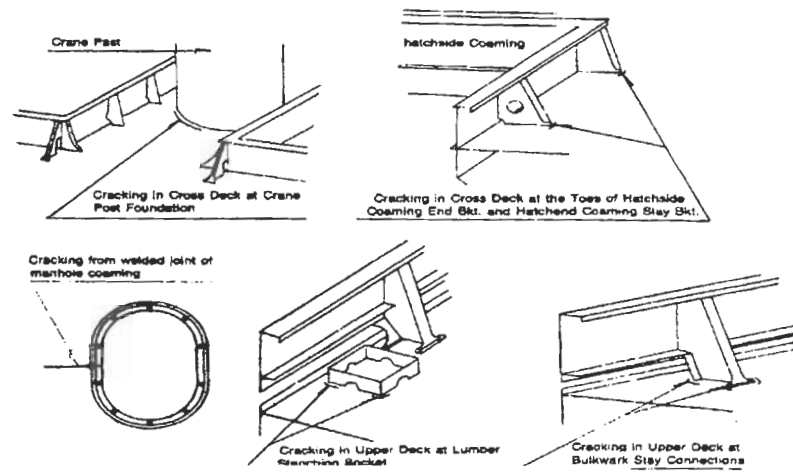

Figure 6: Cracking at hatchway

.2 *Upper deck plating at deck fittings*

Various metal fittings are welded to the upper deck plating. These installations may cause stress concentrations at the welded joints or have defects in the welds. Deck platings in the vicinity of manholes, hatchside coaming end brackets, bulwark stays, crane post foundations and deck houses, etc. are to be carefully watched for cracking.



**Figure 7: Various crackings in upper deck plating**

### 3 *Hatch coamings*

Hatch coamings are subjected to hull girder stress. Although they are not critical longitudinal strength members, they should be watched carefully to ensure that these cracks do not spread. Cracking may be initiated at defects in welded joints and metal fittings to the coamings that will invite stress concentration. Such cracking is considered serious to the ship's safety because it may be the initiation of a fracture on a large scale.

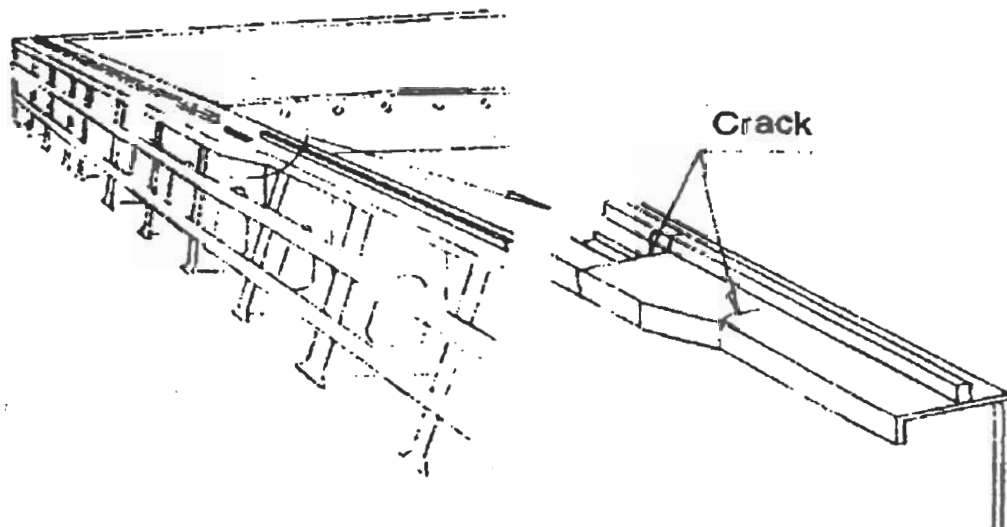

**Figure 8: Cracking in hatch coaming**

### **Corrosion on deck**

6.1.6 Thinner steel structures on deck, such as cross deck strips, hatch coamings, hatch covers, etc., are easily corroded and often holed. The best way to deter corrosion is to keep the structure well coated and painted. The parts most liable to corrosion in the upper deck area are as follows:

.1 *Cross deck strips*

The thickness of cross deck plating between hatchways is designed about a half of that of main strength deck plating because it is not a longitudinal strength member. However, cross deck strips provide an important part of the transverse strength of the ship, and corrosion and waste of the cross deck plating may be considered serious to the ship's soundness.

	L (m)	At main deck plating	At cross deck strip
Handy bulk carrier	177.00	17.5 mm (32 H/T)	10.0 mm (MS)
Panamax bulk carrier	215.00	20.5 mm (36 H/T)	10.5 mm (MS)
Capesize bulk carrier	280.0	33.0 mm (40 H/T)	12.0 mm (MS)

**Figure 9: Examples of comparison of thickness of main deck and cross deck**

.2 *Hatch covers*

The thickness of hatch covers is approximately the same as that of cross decks. Holes in hatch covers caused by corrosion lead to water ingress in cargo holds, which may lead to shifting of cargo and/or problems with the stability of the ship.

.3 *Hatch coamings*

When steam pipes are arranged beside hatchside coamings, the corrosion progress of the coaming is very rapid. Corrosion holes of the coaming plates lead to the same problems as those associated with hatch cover corrosion.

.4 *Weathertight doors, small hatches and wall ventilator covers*

Not only covers, door plates and coamings but also hinges, gaskets and clips are to be always kept in good condition.

.5 *Standing pipes on deck*

Vent and sounding pipes from water ballast or fuel oil tanks and ventilation pipes for closed spaces under the upper deck are liable to corrosion. If these pieces become holed, seawater comes directly into the tanks or cargo holds and may cause contamination of fuel oil, cargo damage, shifting of cargo, and/or stability problems.

.6 *Forecastle aft wall*

The bilges in forecastle space may cause corrosion of the bulkhead where it meets the deck. In flush decked bulk carriers, the boatswain store aft wall may be corroded in the same manner. Large bulk carriers generally do not have forecastle and have their boatswain stores down below the upper deck in fore peak spaces. Bilges left in such spaces also cause corrosion of the aft end bulkheads which separates boatswain store and No.1 cargo hold. Such wastage may lead to water ingress, cargo damage, cargo shifting, and/or stability problems.

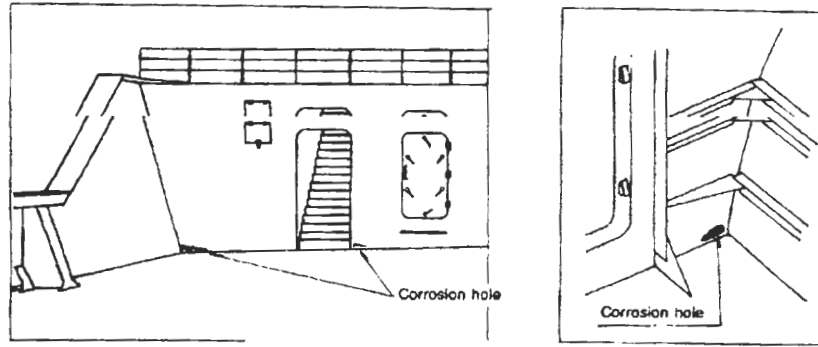

Figure 10: Forecastle end bulkhead

6.2 Cargo holds

Structural features

6.2.1 On typical bulk carriers, the topside and bilge hopper tanks compose a double hull surrounding the cargo space, which together with the double bottom provides hull strength and rigidity. Single hulled side shells provided with individual transverse frames are located between the topside and bilge hopper tanks. In recent designs, these hold frames and end brackets are thinner than the side shell and are not constructed with web frames and side stringers as is the case with general cargo carriers.

Below is a comparison of thickness of hull skin plates and hold frames in cargo hold.

	Tanktop (mm)	Hold Frame (mm)			Side shell (mm)
		Web	Face	End bracket	
Handy BC	15.0 (MS)	9.0 (MS)	12.0 (MS)	10.0 (MS)	12.5 (MS)
Panamax BC	17.0 (MS)	10.0 (36HT)	12.5 (36HT)	11.0 (36HT)	15.5 (32HT)
Capesize BC	18.5 (36HT)	10.0 (36HT)	17.0 (36HT)	12.0 (36HT)	17.5 (32HT)

Figure 11: Comparison of thickness of hull skin and hold frames

Corrosion and waste of hold frames

6.2.2 Corrosion generally attacks thinner steel structures and is accelerated in thinner plates. In the time a thicker steel plate loses half of its original thickness a thinner plate might corrode completely.

6.2.3 Among the various members composing cargo hold structures, the hold frames are usually the thinnest structures, especially at the web plates. In addition, the hold frames also have more surface area exposed, in that both surfaces of the plate are susceptible.

6.2.4 This may mean accelerated corrosion in the hold frames, the thinnest among all the members in cargo holds. If corrosion and waste become excessive, failure of hold frames invites additional loads to the adjacent ones, which may lead to failure throughout the side shell structure.

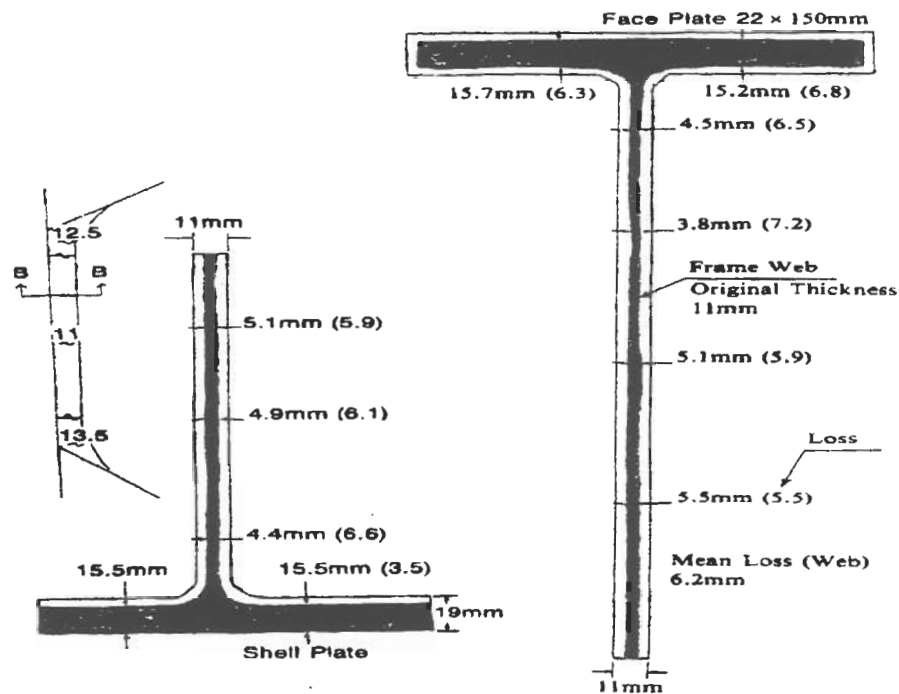

**Figure 12: An example of a corroded hold frame**

6.2.5 Transverse bulkheads may also be susceptible to accelerated corrosion, particularly at the midheight and at the bottom. Particular care should be exercised when inspecting hold frames and transverse bulkheads, in that these members may appear in deceptively good condition. Tanktop and side shell plating generally corrode from the steel surface facing the cargo hold and corrosion from inside the double bottom is usually less than that from cargo hold side.

6.2.6 Regarding the corrosiveness of cargoes, coal is among the most corrosive of cargoes carried on board bulk carriers. Thickness measurement surveys reveal that bulk carriers which have been employed in carriage of coal suffer more serious corrosion to their cargo holds than those engaged in the carriage of any other cargoes.

6.2.7 Cargo hold frames should also be carefully inspected for mechanical damage, corrosion and waste, because many cargoes will damage hold frames through direct contact. This damage will invite corrosion from seawater brought on board in loading operations.

6.2.8 The most important aspects of cargo hold inspections are the condition of side shell structures and their reinforcements. Special attention should be paid to the condition of hold frames and their connection to the shell plating.

**Transbulkheads and associated structures**

6.2.9 Bulk carrier watertight transverse bulkheads at the ends of dry cargo holds are constructed in various ways, which in general can be categorized as either vertically corrugated with or without upper or lower stools, double plated with or without upper or lower stools, or plane bulkheads vertically stiffened.

6.2.10 It may be necessary that certain holds bounded by the foregoing categories of bulkheads are partially filled with water ballast in order to achieve a satisfactory air draught at the loading/discharge berths. The filling is restricted to correspond to the dry cargo hold scantlings. However, for deep tank corrugated bulkheads at the ends of cargo holds which are designed to be fully filled with water ballast, the scantlings are increased substantially from that for ordinary watertight transverse bulkheads.

6.2.11 The opportunity is taken to emphasize that for ordinary transverse watertight bulkheads, in addition to withstanding water pressure in an emergency situation, i.e., flooding, the bulkhead structures constitute the main structural strength elements in the structural design of the intact vessel. Ensuring that acceptable strength is maintained for these structures is therefore of major importance.

6.2.12 The structure may sometimes appear to be in good condition when it is in fact excessively corroded. In view of this, appropriate access arrangements should be provided to enable a proper close-up inspection and thickness assessment.\*

6.2.13 It is imperative to realize that in the event of one hold flooding, the transverse watertight bulkheads prevent progressive flooding and therefore also prevent the ship from sinking.

#### **What to look for**

6.2.14 The following are examples of the more common damage/defects that may occur:

- .1 *Fractures* at the boundaries of corrugations and bulkhead stools, particularly in way of shelf plates, shredder plates, deck, inner bottom, etc.
- .2 *Buckling* of the plating/corrugations, leading to the failure and collapse of the bulkhead under water pressure in an emergency situation.
- .3 *Excessive wastage/corrosion*, in particular at the midheight and bottom of bulkheads, which may look in deceptively good condition. This is created by the corrosive effect of cargo and environment, in particular when the structure is not coated. In this respect special attention should be given to the following areas:
  - .3.1 bulkhead plating adjacent to the shell plating;
  - .3.2 bulkhead trunks which form part of the venting, filling and discharging arrangements between the topside tanks and the hopper tanks;
  - .3.3 bulkhead plating and weld connections to the lower/upper stool shelf plates;
  - .3.4 weld connections of stool plating to the lower/upper stool shelf plates and inner bottom;
  - .3.5 in way of weld connections to topside tanks and hopper tanks;

---

\*Refer to section 5.3 of annex A to resolution A.744(18), Guidelines on the enhanced programme of inspections during surveys of bulk carriers and oil tankers, as amended, and to the Guidelines on the means of access to structures for inspection and maintenance of oil tankers and bulk carriers (MSC/Circ.686).

- .3.6 any areas where coatings have broken down and there is evidence of corrosion or wastage. It is recommended that random thickness determination be taken to establish the level of diminution; and
- .3.7 other structures, e.g., diaphragms inside the stools, particularly at their upper and lower weld connections.

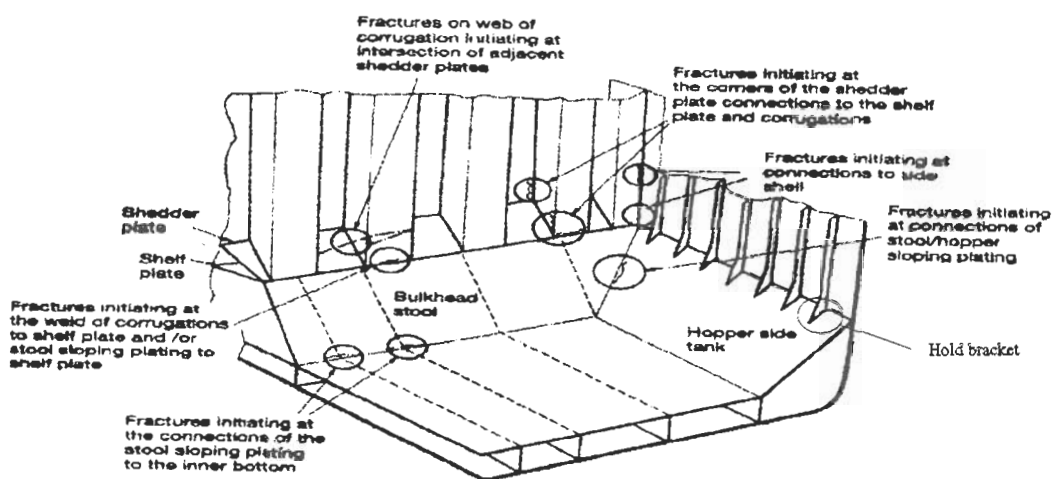

Figure 13: Typical fracturing at the connection of transverse bulkhead structure

**Damage caused by cargoes**

6.2.15 In cargo holds, tanktop plating and side shell structures are apt to be damaged by cargo handling operations.

6.2.16 At loading and unloading ports for coal or iron ore, large grab buckets, high capacity cargo loaders, bulldozers and pneumatic hammers may be employed for cargo handling operations.

6.2.17 Large grab buckets may cause considerable damage to tanktop plating when being dropped to grab cargo. Use of bulldozers and pneumatic hammers may also be harmful to cargo hold structures and may result in damage to tanktops, bilge hoppers, hold frames and end brackets.

6.2.18 Lumber cargoes may also cause damage to the cargo hold structures of smaller bulkers that are employed in the carriage of light bulk cargoes and lumbers.

**Cracking**

6.2.19.1 Combination cargo/ballast hold

In bulk carriers having combination cargo/ballast holds, cracks may often be found at or near the connection of the stool of the transverse bulkhead and the tank top.

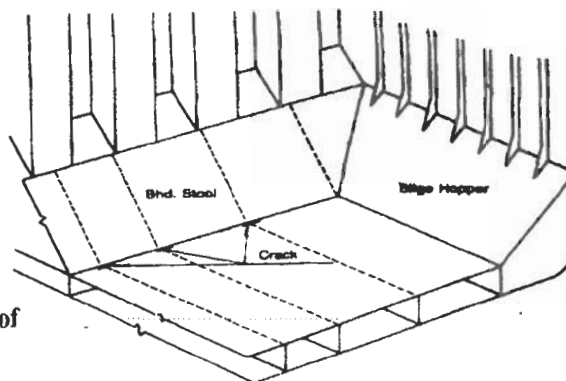

**Figure 14: Cracking at the connection of bulkhead stool and tanktop**

All capesize and panamax bulk carriers and some handy bulkers have combination cargo/ballast hold(s) to keep the necessary draught. The bulkhead boundaries of the spaces are designed to comply with the requirements for deep tank bulkheads. In these holds cracks may often be found at the connection between the transverse bulkhead and the tanktop. These cracks can be detected by visual inspection or by noting leakage from the double bottom tanks.

#### 6.2.19.2 Others

Side stringers and/or side shells in way of No.1 cargo hold along the collision bulkhead are often found cracked. This kind of damage is considered to be caused by insufficient continuity between fore peak construction and cargo hold structure.

On large bulk carriers such as capesize and panamax bulkers, bilge hopper plating around the knuckle line may be cracked along the bilge hopper transverse webs. This is considered to be caused by insufficient local reinforcement.

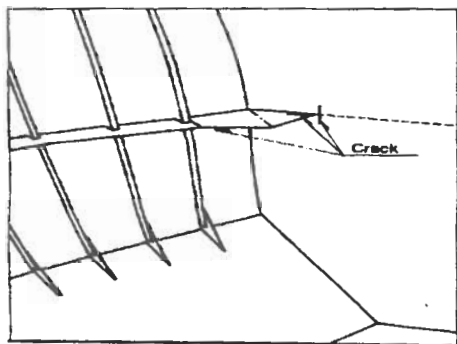

**Figure 15: Cracking around the collision bulkhead**

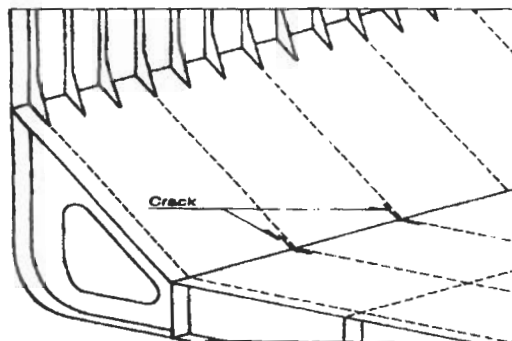

**Figure 16: Cracking in bilge hopper**

### 6.3 Topside tanks

6.3.1 Corrosion and wastage of steel, especially in the upper part of the topside tanks, should be carefully watched.

6.3.2 Though the water ballast tanks of newer bulk carriers are well protected against corrosion, the upper portion is susceptible to corrosion because the protective coating will easily deteriorate due to heat from the upper deck and the cyclic wet/dry effect of seawater.

## 6.4 Bilge hopper/double bottom tanks

6.4.1 When carrying out inspections of these tanks, particular attention should be paid to any cracking, deformation or deterioration of coating.

### Cracking in bilge hopper and double bottom tanks

6.4.2 Cracks may be found at the intersections of longitudinals and transverse members and at other locations as follows:

.1 *Intersections of longitudinals and solid floors*

Cracks may be found in the side, bottom and/or tanktop longitudinals at intersections with solid floors or bilge hopper transverses. Cracks also may be found in the floors or transverses occurring at the corners of the slots cut for longitudinals.

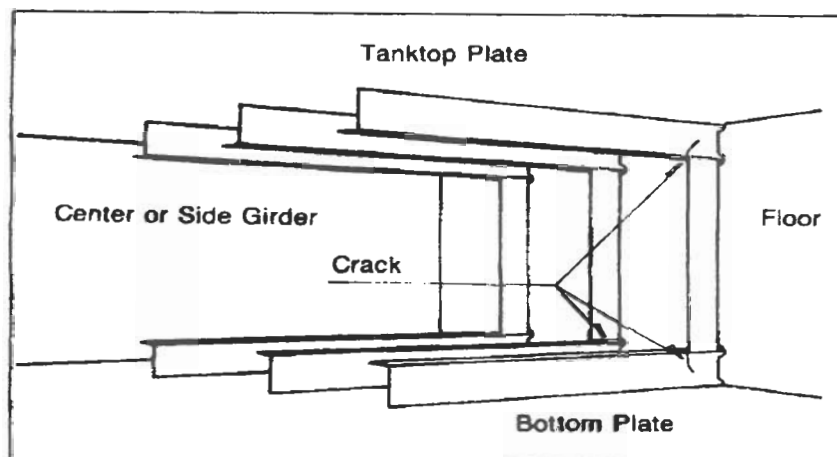

Figure 17: Cracking in tanktop/bottom longitudinals

.2 *Cracking of longitudinals at areas of structural discontinuity*

Longitudinals may be cracked at the ends of additional (partial) side girders provided in the double bottom below cargo hold bulkheads or at the side walls of bilge wells for cargo holds, due to additional stress concentration caused by the structural discontinuity at those connections.

I:\ASSEMBLY\20\RES\866.

The fuel oil heating system was adopted following changes to the properties of fuel oil, mainly an increase in viscosity. For economic reasons, ship operators began to use low grade bunker oil which needs heating in order to decrease the viscosity. At the beginning of this trend, the temperature required in the fuel oil tanks was not high enough to accelerate the corrosion of the steel in the adjacent spaces. However, in recent years, the grade of bunker oil being used requires the temperature in the tank to be 80°C or more. Such a temperature can accelerate corrosion of the steel in the tanks, particularly in the vicinity of the boundaries of the fuel oil tanks.

I:\ASSEMBLY\20\RES\866.

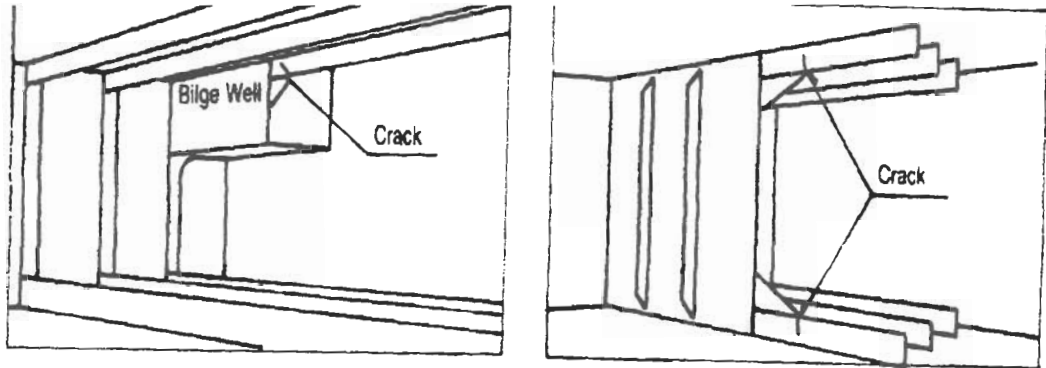
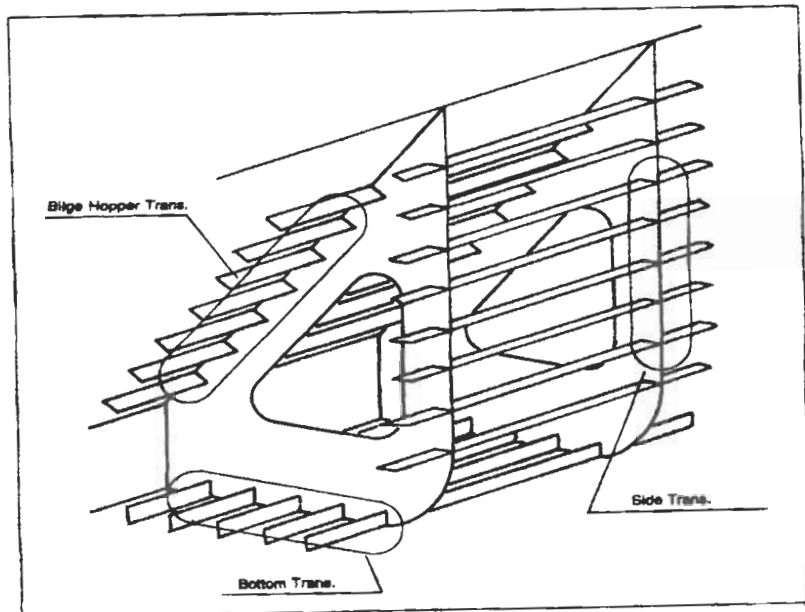

**Figure 18: Cracking at the end connection with side walls of bilge well**

**Cracking at the end of an additional girder**

.3 *Bilge hopper transverse*

Cracks may be observed in transverse webs in bilge hoppers initiating from the slot openings for longitudinals and at the knuckled corners of the lower ends of the hoppers.



**Figure 19: Check points in bilge hopper transverse**

## Corrosion

6.4.3 Corrosion must be carefully watched in the inspection of water ballast tanks, particularly in older bulk carriers over 10 years of age. In general, the condition of the steel and protective coatings will be in satisfactory condition much longer in the double bottoms than in the topside compartments. However, even double bottom tanks will deteriorate in time due to the continual ballasting of the ship.

.1 *Corrosion accelerated by heat*

Since the late '70s, problems with heavy corrosion in double bottom water ballast tanks adjacent to fuel oil tanks have appeared. In some cases, the corrosion was worse in areas closer to the fuel oil tank boundaries. In those ships, fuel oil tanks were installed.

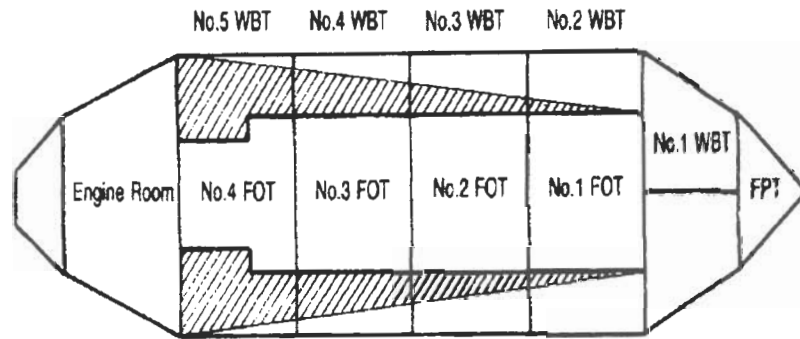

**Figure 20: Areas where heavy corrosion due to heat effect may be found (hatched areas)**

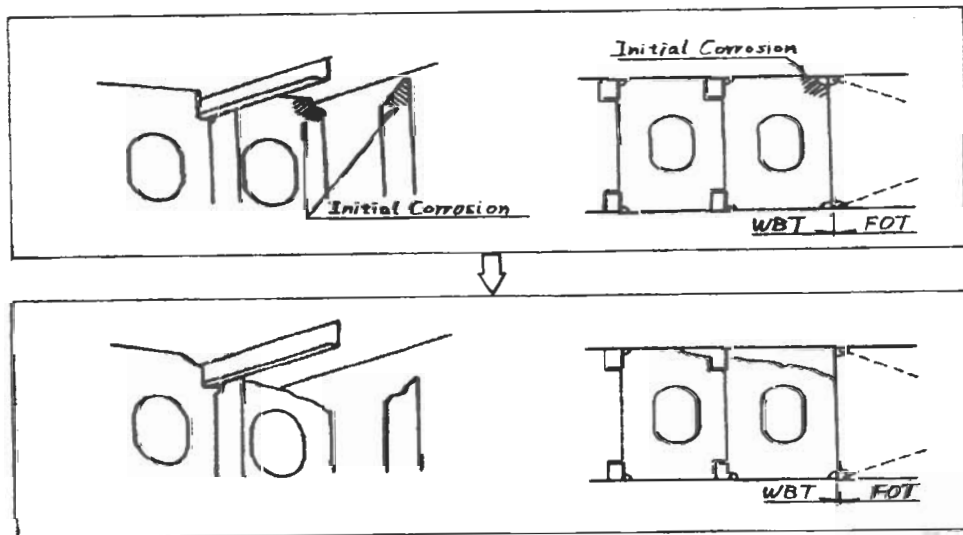

**Figure 21: Progress of corrosion in water ballast tanks adjacent to fuel oil tanks (FOT)**

The fuel oil heating system was adopted following changes to the properties of fuel oil, mainly an increase in viscosity. For economic reasons, ship operators began to use low grade bunker oil which needs heating in order to decrease the viscosity. At the beginning of this trend, the temperature required in the fuel oil tanks was not high enough to accelerate the corrosion of the steel in the adjacent spaces. However, in recent years, the grade of bunker oil being used requires the temperature in the tank to be 80°C or more. Such a temperature can accelerate corrosion of the steel in the tanks, particularly in the vicinity of the boundaries of the fuel oil tanks.

.2 *Areas under suction bell mouths*

Bottom plates are often eroded under the suction bell mouths in tanks. On drydocking of an older ship, the bell mouths should be dismantled for examination of the condition of the shell plates below the bell mouths.

## 6.5 Other notices

### Bottom ends of sounding pipes

6.5.1 A sounding pipe has a pad plate at its bottom end for protection of the tank bottom against the strike of the sounding scale's lead. During inspections the extent of diminution of the protection plate should be examined.

### Connection trunk between topside and bilge hopper spaces

6.5.2 Connection trunks provided between topside and bilge hopper spaces are to be carefully watched for signs of corrosion and waste of the steel works inside.

6.5.3 On some bulk carriers, bilge hopper tanks and topside tanks form one integral tank connected with trunk spaces. The inside surface of a connection trunk is liable to corrosion and should be examined carefully.

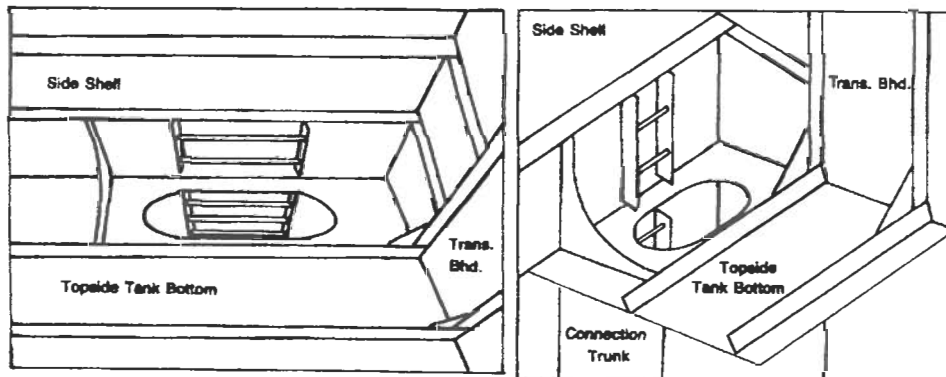

**Figure 22: Connection trunk entrance in topside tank**